



Not all products are qualified on the DLC QPL. To view our DLC qualified products, please consult the DLC Qualified Products List at www.designlights.org/qpl.

ECO™ EXT (NON-DIMMABLE)



www.trulygreensolutions.com

Features



3 LENGTHS
AVAILABLE IN
10W/15W/18W



EXPECTED LIFE
OVER 50,000 HRS



IES FILES @
www.trulygreensolutions.com



SUITABLE FOR
DAMP LOCATIONS



GLARE FREE
PC LENS

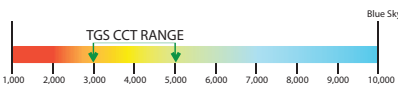

SELECTION OF
COLOR RANGES

- Type A : Ballast Compatible
- Type B : Bypass Ballast
- Type A/B : Ballast Compatible
or Bypass Ballast
- Type C : External Power**



MULTIPLE
TUBE/ DRIVER
COMBINATIONS



Not all products are qualified on the DLC® QPL. To view our DLC® qualified products, please consult the DLC® Qualified Products List at www.design-lights.org/qpl.

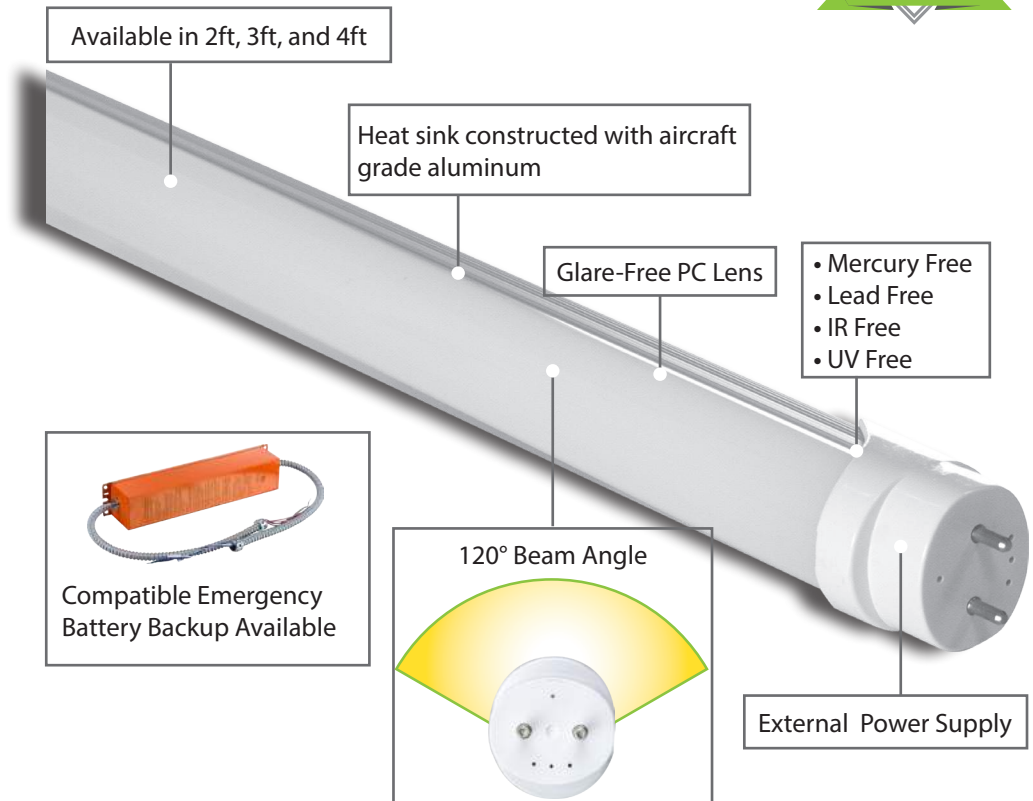

Applications



Parking Garage



Mall



Storage Facility





Replaces 4' T8
Fluorescent Tubes

Highlights

The TGS Eco™ EXT LED T8 lamp offers an easy and safe energy-saving retrofit solution for fluorescent T8 tubes, with 130 lumens per watt. The long-lasting and high-quality Eco™ EXT is powered by an external driver, allowing bypass of the existing ballast to eliminate compatibility issues and maintenance costs associated with ballasts.

The Eco™ EXT LED T8 lamp provides superior quality uniform, flicker-free lighting in a complete package. It uses about half the energy as fluorescent T8 tubes, with up to 70% reduction of overall operating costs. The UL, cUL, and RoHS certified lamps are available in 2', 3' and 4' lengths, in 3 different wattages (10W, 15W, and 18W), with the form, fit and function of traditional T8 fluorescent lamps. The Eco™ EXT is constructed with a polycarbonate optical diffuser, which provides a wide beam angle of 120° for comprehensive spatial illumination.

Featuring a unique advanced heat sink technology that ensures maximum thermal management, the Eco™ EXT is backed by a 5 year/50,000 hour warranty for a long life of maintenance-free service. Available CCT's are 3000K, 3500K, 4000K and 5000K.

Product Dimensions

Length: 47.76 in (1213mm) [Pin to Pin] Weight: 0.80 lbs (365g)
Length: 47.17 in (1198mm) [Cap to Cap] Diameter: 1.02 in (26mm)

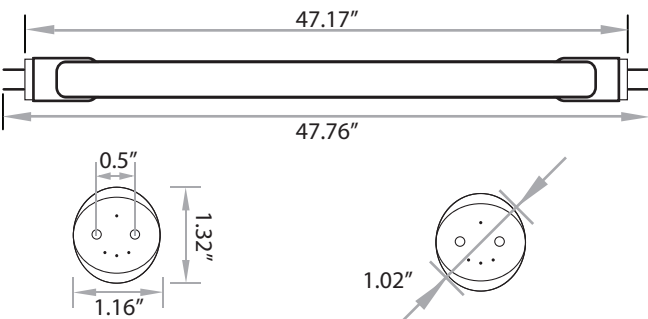

Optical Details

System Efficacy	130 LpW
Lumen Output	1,950 lm
CCT	3000K, 3500K, 4000K, 5000K
Beam Angle	120°
CRI	>80
System Efficiency	N/A

Electrical Details

Input Voltage	100-277V AC (347V Available)
Power Frequency	50-60 Hz
Output Voltage	28-40v
Output Current	540mA
Power Efficiency	90%
Power Factor	>0.90
Total Harmonic Distortion	<20%
Dimmable	No

Other Details

System Power Usage	15W
LED Power Usage	N/A
Fixture Material	Aluminum Base and PC Housing
Finish	N/A
Ingress Protection	Suitable For Damp Locations
Luminaire Net Weight	0.80 lbs (365g)
Lifespan	50,000+ Hours
Storage Temperature	-4°~122°F
Operating Temperature	-4°~104°F
Operating Humidity	N/A
Product Dimension	47.76x1.02 in (pin to pin)
Replaces	T8 Fluorescent

Application

• Offices	• Hospitals
• Industrial Shops	• Hotels
• Schools	• High / Low Bay
• Commercial Buildings	• Troffers / Strips

Base Options

• G13 Pin (Bi-pin)



Driver Dimensions

Input

Wire Color	Assignment
Red	AC L
Black	AC N

Output

Wire Color	Assignment
Red	LED 1 +
Black	LED 1 -

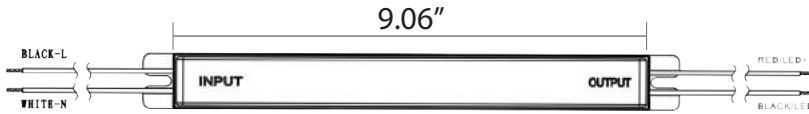

Rated Power: 10W Rated Current: 300mA
 Frequency: 50-60Hz DC Voltage: 36V
 Voltage Range: 100-277V AC Constant Current Region: 28-36V

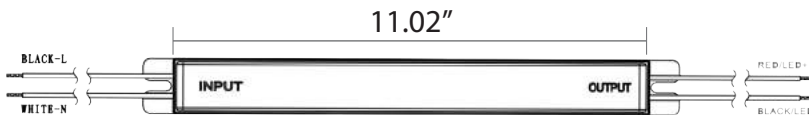
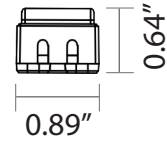

Rated Power: 15W Rated Current: 380mA
 Frequency: 50-60Hz DC Voltage: 40V
 Voltage Range: 100-277V AC Constant Current Region: 30-40V

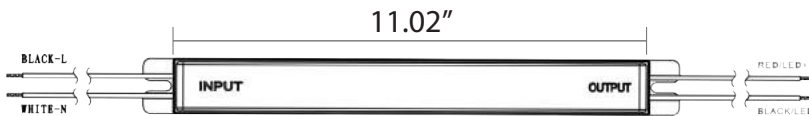
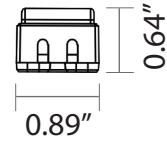

Rated Power: 18W and 22W Rated Current: 540mA
 Frequency: 50-60Hz DC Voltage: 40V
 Voltage Range: 100-277V AC Constant Current Region: 30-40V

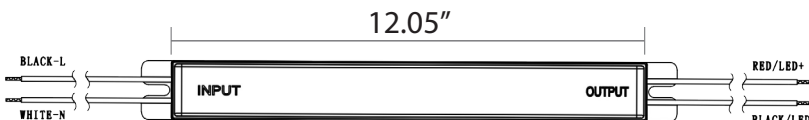
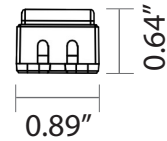

Rated Power: 30W Rated Current: 700mA
 Frequency: 50-60Hz DC Voltage: 40V
 Voltage Range: 100-277V AC Constant Current Region: 30-40V

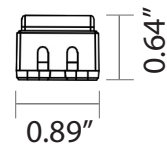

Driver Dimensions

Input

Wire Color	Assignment
Red	AC L
Black	AC N

Output

Wire Color	Assignment
Red	LED 1 +
Black	LED 1 -

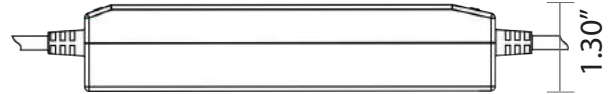
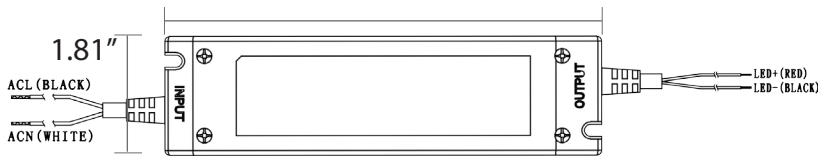

Rated Power: 40W
Frequency: 50-60Hz
Voltage Range: 100-277V AC

Rated Current: 1000mA
DC Voltage: 40V

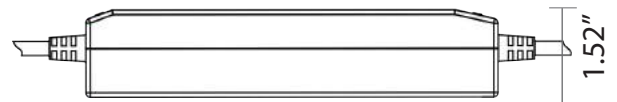
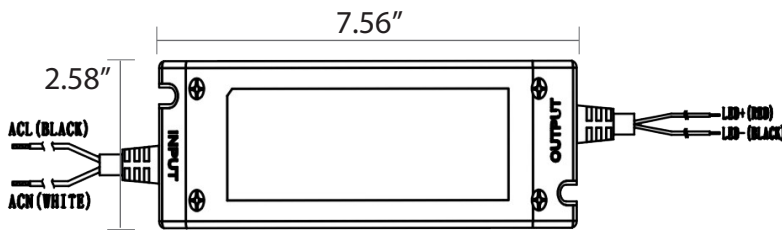

Rated Power: 50W
Frequency: 50-60Hz
Voltage Range: 100-277V AC

Rated Current: 1500mA
DC Voltage: 28-40V

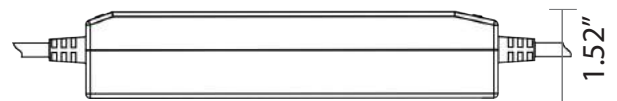
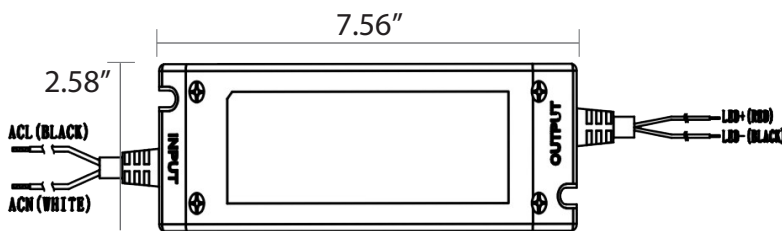

Rated Power: 60W
Frequency: 50-60Hz
Voltage Range: 100-277V AC

Rated Current: 1680mA
DC Voltage: 28-40V



Lumen Packages



1 Tube/1 Driver:	Driver:
10W (2') = 1,300 lm	10W
10W (3') = 1,300 lm	10W
15W (4') = 1,950 lm	15W
18W (4') = 2,340 lm	22W



3 Tube/1 Driver:	Driver:
10W (2') = 3,900 lm	30W
10W (3') = 3,900 lm	30W
15W (4') = 5,850 lm	40W
18W (4') = 7,020 lm	60W



2 Tube/1 Driver:	Driver:
10W (2') = 2,600 lm	22W
10W (3') = 2,600 lm	22W
15W (4') = 3,900 lm	30W
18W (4') = 4,680 lm	40W



4 Tube/1 Driver:	Driver:
10W (2') = 5,200 lm	40W
10W (3') = 5,200 lm	40W
15W (4') = 7,800 lm	50W

*4 Tube 2 Driver
Also Available

10W is available in 2' and 3'
15 and 18W are available in 4'



Ordering Information

***Note:**
 - 10W Available in 2' and 3'
 - 15W and 18W Available in 4'

EXAMPLE NUMBER: 832110-40-L-F-A-D

83	Length	Wattage	CCT	Company Code	Lens Cover	Tube Quantity	D
ECO™ EXT (Type C)	21 - 24"	10 - 10W	50 - 5000K 40 - 4000K 35 - 3500K 30 - 3000K	L	F - Frosted	A - One Tube One Driver B - Two Tube One Driver C - Three Tube One Driver D - Four Tube One Driver	D

EXAMPLE NUMBER: 833110-40-L-F-A-D

83	Length	Wattage	CCT	Company Code	Lens Cover	Tube Quantity	D
ECO™ EXT (Type C)	31 - 36"	10 - 10W	50 - 5000K 40 - 4000K 35 - 3500K 30 - 3000K	L	F - Frosted	A - One Tube One Driver B - Two Tube One Driver C - Three Tube One Driver D - Four Tube One Driver	D

EXAMPLE NUMBER: 834115-40-L-F-A-D

83	Length	Wattage	CCT	Company Code	Lens Cover	Tube Quantity	D
ECO™ EXT (Type C)	41 - 48"	15 - 15W	50 - 5000K 40 - 4000K 35 - 3500K 30 - 3000K	L	F - Frosted	A - One Tube One Driver B - Two Tube One Driver C - Three Tube One Driver D - Four Tube One Driver	D

EXAMPLE NUMBER: 834118-40-L-F-A-D

83	Length	Wattage	CCT	Company Code	Lens Cover	Tube Quantity	D
ECO™ EXT (Type C)	41 - 48"	18 - 18W	50 - 5000K 40 - 4000K 35 - 3500K 30 - 3000K	L	F - Frosted	A - One Tube One Driver B - Two Tube One Driver C - Three Tube One Driver	D

Emergency Battery Backup Accessory Options

EXAMPLE NUMBER: 90018-H

900	Wattage	High Voltage
High Voltage LED Emergency Battery Backup	18 - 18W 25 - 25W	H

Accessory: Tombstone

EXAMPLE NUMBER: 9913-B

Tombstones	
Tombstones	9913-B (Shunted Tombstone Socket - Double-End Power)

For **One Tube and One Driver** replace the “X” with “A” in the SKU number:
EXAMPLE NUMBER: 832110-50-L-F-[A]-D

One Tube and One Driver SKU Numbers:

SKU Number	Base Type	Wattage	Color Temp (K)	Dimensions	Lumens (lm)	Input Voltage	Warranty	DLC® Qualified
832110-50-L-F-X-D	G13	10W	5000	23.62"x1.02"	1,300	100-277V	5 year	Yes
832110-40-L-F-X-D	G13	10W	4000	23.62"x1.02"	1,300	100-277V	5 year	Yes
832110-35-L-F-X-D	G13	10W	3500	23.62"x1.02"	1,300	100-277V	5 year	Yes
832110-30-L-F-X-D	G13	10W	3000	23.62"x1.02"	1,300	100-277V	5 year	Yes
833110-50-L-F-X-D	G13	10W	5000	35.71"x1.02"	1,300	100-277V	5 year	No
833110-40-L-F-X-D	G13	10W	4000	35.71"x1.02"	1,300	100-277V	5 year	No
833110-35-L-F-X-D	G13	10W	3500	35.71"x1.02"	1,300	100-277V	5 year	No
833110-30-L-F-X-D	G13	10W	3000	35.71"x1.02"	1,300	100-277V	5 year	No
834115-50-L-F-X-D	G13	15W	5000	47.76"x1.02"	1,950	100-277V	5 year	Yes
834115-40-L-F-X-D	G13	15W	4000	47.76"x1.02"	1,950	100-277V	5 year	Yes
834115-35-L-F-X-D	G13	15W	3500	47.76"x1.02"	1,950	100-277V	5 year	Yes
834115-30-L-F-X-D	G13	15W	3000	47.76"x1.02"	1,950	100-277V	5 year	Yes
834118-50-L-F-X-D	G13	18W	5000	47.76"x1.02"	2,340	100-277V	5 year	Yes
834118-40-L-F-X-D	G13	18W	4000	47.76"x1.02"	2,340	100-277V	5 year	Yes
834118-35-L-F-X-D	G13	18W	3500	47.76"x1.02"	2,340	100-277V	5 year	Yes
834118-30-L-F-X-D	G13	18W	3000	47.76"x1.02"	2,340	100-277V	5 year	Yes

For **Two Tube and One Driver** replace the “X” with “B” in the SKU number:
EXAMPLE NUMBER: 832110-50-L-F-[B]-D

Two Tube and One Driver SKU Numbers:

SKU Number	Base Type	Wattage	Color Temp (K)	Dimensions	Lumens (lm)	Input Voltage	Warranty	DLC® Qualified
832110-50-L-F-X-D	G13	10W	5000	23.62"x1.02"	2,600	100-277V	5 year	Yes
832110-40-L-F-X-D	G13	10W	4000	23.62"x1.02"	2,600	100-277V	5 year	Yes
832110-35-L-F-X-D	G13	10W	3500	23.62"x1.02"	2,600	100-277V	5 year	Yes
832110-30-L-F-X-D	G13	10W	3000	23.62"x1.02"	2,600	100-277V	5 year	Yes
833110-50-L-F-X-D	G13	10W	5000	35.71"x1.02"	2,600	100-277V	5 year	No
833110-40-L-F-X-D	G13	10W	4000	35.71"x1.02"	2,600	100-277V	5 year	No
833110-35-L-F-X-D	G13	10W	3500	35.71"x1.02"	2,600	100-277V	5 year	No
833110-30-L-F-X-D	G13	10W	3000	35.71"x1.02"	2,600	100-277V	5 year	No
834115-50-L-F-X-D	G13	15W	5000	47.76"x1.02"	3,900	100-277V	5 year	Yes
834115-40-L-F-X-D	G13	15W	4000	47.76"x1.02"	3,900	100-277V	5 year	Yes
834115-35-L-F-X-D	G13	15W	3500	47.76"x1.02"	3,900	100-277V	5 year	Yes
834115-30-L-F-X-D	G13	15W	3000	47.76"x1.02"	3,900	100-277V	5 year	Yes
834118-50-L-F-X-D	G13	18W	5000	47.76"x1.02"	4,680	100-277V	5 year	Yes
834118-40-L-F-X-D	G13	18W	4000	47.76"x1.02"	4,680	100-277V	5 year	Yes
834118-35-L-F-X-D	G13	18W	3500	47.76"x1.02"	4,680	100-277V	5 year	Yes
834118-30-L-F-X-D	G13	18W	3000	47.76"x1.02"	4,680	100-277V	5 year	Yes



Not all products are qualified on the DLC® QPL. To view our DLC® qualified products, please consult the DLC® Qualified Products List at www.design-lights.org/qpl.



For **Three Tube and One Driver** replace the "X" with "C" in the SKU number:
EXAMPLE NUMBER: 832110-50-L-F-[C]-D

Three Tube and One Driver SKU Numbers:

SKU Number	Base Type	Wattage	Color Temp (K)	Dimensions	Lumens (lm)	Input Voltage	Warranty	DLC® Qualified
832110-50-L-F-X-D	G13	10W	5000	23.62"x1.02"	3,900	100-277V	5 year	Yes
832110-40-L-F-X-D	G13	10W	4000	23.62"x1.02"	3,900	100-277V	5 year	Yes
832110-35-L-F-X-D	G13	10W	3500	23.62"x1.02"	3,900	100-277V	5 year	Yes
832110-30-L-F-X-D	G13	10W	3000	23.62"x1.02"	3,900	100-277V	5 year	Yes
833110-50-L-F-X-D	G13	10W	5000	35.71"x1.02"	3,900	100-277V	5 year	No
833110-40-L-F-X-D	G13	10W	4000	35.71"x1.02"	3,900	100-277V	5 year	No
833110-35-L-F-X-D	G13	10W	3500	35.71"x1.02"	3,900	100-277V	5 year	No
833110-30-L-F-X-D	G13	10W	3000	35.71"x1.02"	3,900	100-277V	5 year	No
834115-50-L-F-X-D	G13	15W	5000	47.76"x1.02"	5,850	100-277V	5 year	Yes
834115-40-L-F-X-D	G13	15W	4000	47.76"x1.02"	5,850	100-277V	5 year	Yes
834115-35-L-F-X-D	G13	15W	3500	47.76"x1.02"	5,850	100-277V	5 year	Yes
834115-30-L-F-X-D	G13	15W	3000	47.76"x1.02"	5,850	100-277V	5 year	Yes
834118-50-L-F-X-D	G13	18W	5000	47.76"x1.02"	7,020	100-277V	5 year	Yes
834118-40-L-F-X-D	G13	18W	4000	47.76"x1.02"	7,020	100-277V	5 year	Yes
834118-35-L-F-X-D	G13	18W	3500	47.76"x1.02"	7,020	100-277V	5 year	Yes
834118-30-L-F-X-D	G13	18W	3000	47.76"x1.02"	7,020	100-277V	5 year	Yes

For **Four Tube and One Driver** replace the "X" with "D" in the SKU number:
EXAMPLE NUMBER: 832110-50-L-F-[D]-D

Four Tube and One Driver SKU Numbers:

SKU Number	Base Type	Wattage	Color Temp (K)	Dimensions	Lumens (lm)	Input Voltage	Warranty	DLC® Qualified
832110-50-L-F-X-D	G13	10W	5000	23.62"x1.02"	5,200	100-277V	5 year	Yes
832110-40-L-F-X-D	G13	10W	4000	23.62"x1.02"	5,200	100-277V	5 year	Yes
832110-35-L-F-X-D	G13	10W	3500	23.62"x1.02"	5,200	100-277V	5 year	Yes
832110-30-L-F-X-D	G13	10W	3000	23.62"x1.02"	5,200	100-277V	5 year	Yes
833110-50-L-F-X-D	G13	10W	5000	35.71"x1.02"	5,200	100-277V	5 year	No
833110-40-L-F-X-D	G13	10W	4000	35.71"x1.02"	5,200	100-277V	5 year	No
833110-35-L-F-X-D	G13	10W	3500	35.71"x1.02"	5,200	100-277V	5 year	No
833110-30-L-F-X-D	G13	10W	3000	35.71"x1.02"	5,200	100-277V	5 year	No
834115-50-L-F-X-D	G13	15W	5000	47.76"x1.02"	7,800	100-277V	5 year	Yes
834115-40-L-F-X-D	G13	15W	4000	47.76"x1.02"	7,800	100-277V	5 year	Yes
834115-35-L-F-X-D	G13	15W	3500	47.76"x1.02"	7,800	100-277V	5 year	Yes
834115-30-L-F-X-D	G13	15W	3000	47.76"x1.02"	7,800	100-277V	5 year	Yes



Not all products are qualified on the DLC® QPL. To view our DLC® qualified products, please consult the DLC® Qualified Products List at www.design-lights.org/qpl.

