

NOTE

- Please read this entire manual to fully understand and safely use this product.
- Specifications are subject to change without notice.
- Please visit our website the most recent user guide versions.

UNPACKING

- Unpack and carefully examine the product.
- Report any damage and save all packing materials if any part(s) were damaged during shipping.
- Do not attempt to use this apparatus if it is damaged.

IMPORTANT SAFETY INFORMATION



Suitable for Damp location. Access above ceiling required. Suitable for suspended ceilings

READ ALL INSTRUCTIONS BEFORE INSTALLATION

- Consult a qualified electrician to ensure correct branch circuit conductor.
- The product should be installed and operated by a qualified electrician or technician in accordance with relevant local codes.
- Risk of electric shock. Ensure that main power source is off when wiring or soldering the sections of the product.
- Before installing this fixture or doing any maintenance, make sure to turn off the power supply at the circuit breaker or fuse box.
- Check to make sure that all fixture connections have been properly made and the fixture is grounded to avoid potential electrical shocks.
- Do not handle energized fixture when hands are wet, when standing on wet or damp surfaces, or in water.
- This panel lights are normally set to work at extra low voltage below DC42V and constant current conditions to ensure safety to human body.
- Designed for use in 100V~277V,50/60Hz protected circuit. Apply class 2 power supply.

Accessory:

- LED Luminaire
- Installation instruction
- Surface mounted kit (for surface mounted)
- J-box (for recessed)

RECESSED INSTALLATION

Step1: Bend hang buckle by 90° making it vertical to the rear cover of panel light. Same to 4 hang buckles.(Figure 1)

Step2: Turn off power,remove the ceiling panel. Then place the panel in to the T-bar,ensure the panel is attached to the ceiling.(Figure2)

Step3:Remove appropriate round knock-out(s) and connect conduit to J-box with proper connector(s).(Figure3)

Step4:Put a connector to the end of AC input wire and tightly.the line connect to the connector with the black mark, the natural connect to another,the ground connect to the green wire.(Figure4)

Step5:Push all wires back into the junction box,Close J-BOX for cap (Figure 5).

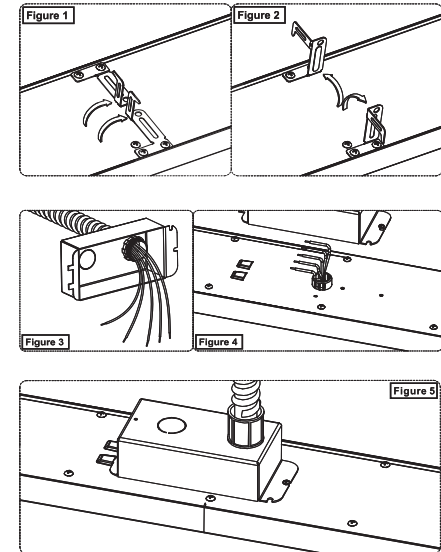

For 0-10V Dimming

Compatible with 0-10V dimmer

The driver PUR (D+) to the dimmer+(PUR),and the driver GRY(D-)to the dimmer-(GRY)

Connect the wires with terminal cap as shown in wiring diagram (Figure 6).

Incoming insulated dimming conductors shall have voltage rated at least equal to the branch voltage.

WIRING DIAGRAM

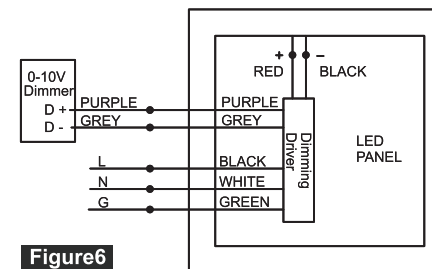
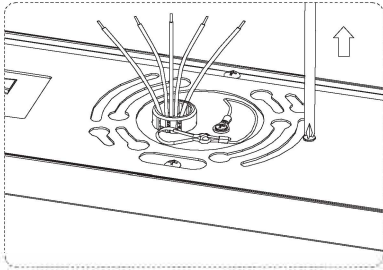
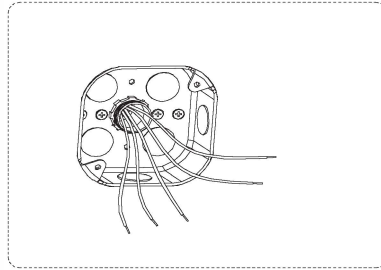

Figure6

Step1: Remove the surface mounted kit from the luminaire.



Step2: Turn off power. Insert the L, N wires of the J-box into the male connector.



Step3: Align the holes on the surface mounted kit with the hole on the J-box. Tighten 2#8-32 screws, rotate the plate to your right position and lots of KA3.5*20mm screws into the ceiling and make the kit flush with the ceiling.

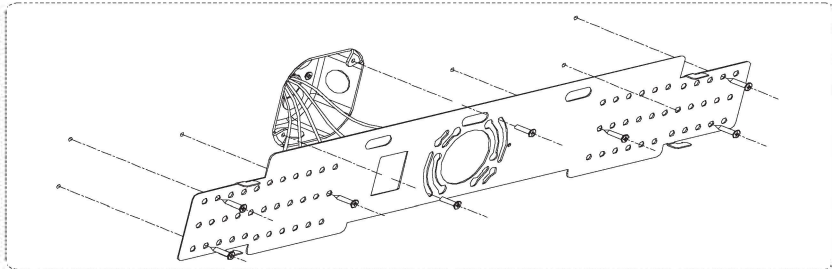

Step4: Secure the safety hook rope to the surface mount kit.

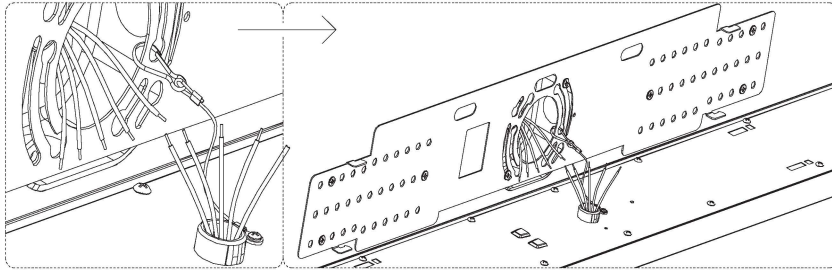

Step5: Plug the female connector of the luminaire into the male connector of the AC input wire. The Ground connects to Green wire. Dimming wires connect according to the same wire color.

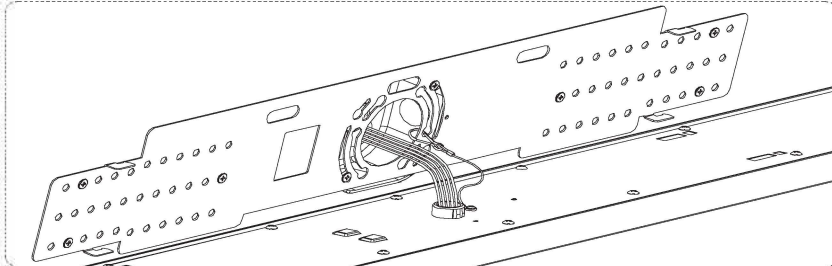

Step6: Align the positions of the fixture and surface mount kit which marked "step 1", and please make sure the hooks on kit align with it matching slot on fixtures.

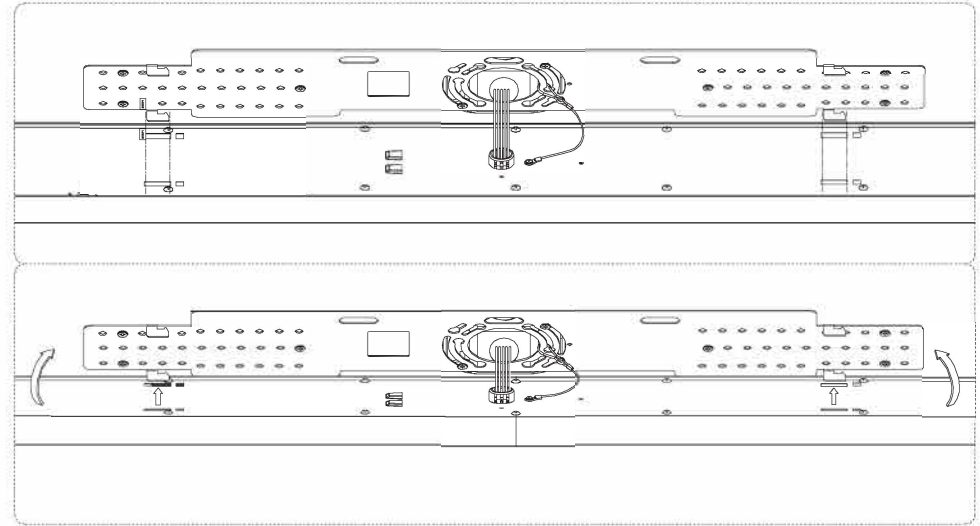

Step7: Push the luminaire on the ceiling. Make sure the 4 hooks are inside the luminaire and push forward the luminaire until you hear a clicking sound.

