

**WARNING**

**PLEASE READ ALL INSTRUCTIONS BEFORE ATTEMPTING INSTALLATION**

- To prevent personal injury or product damage only licensed electricians should install.
- To avoid electric shock or component damage disconnect power before attempting installation or servicing.
- This product must be installed in accordance with the national electric code (NEC) and all applicable federal, state and local electric codes and safety standards.
- Disconnect product and allow cooling prior to servicing.
- Any alteration or modification of this product is expressly forbidden as it may cause serious personal injury, death, property damage and/or product malfunction.
- To prevent product malfunction and/or electrical shock this product must be properly grounded.
- Do not restrict luminaire ventilation.
- Ensure LED luminaire is not covered with material that will prevent convection or conduction cooling.
- Ensure LED luminaire has the correct polarity before installation.
- Avoid exposing wiring to metal edges and sharp objects.
- Driver mounting location varies by application. Use mounting holes provided on driver to mount to a rigid location.
- Driver should not be mounted in or near a fan, air outlet or other HVAC system components.

Instructions do not cover all details and all possible product configurations.

**Installation**

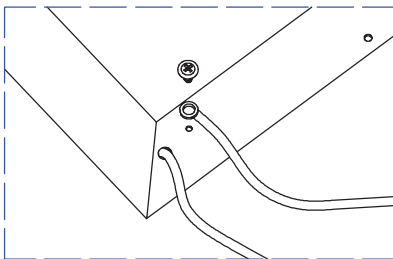

1. Install a safety cable

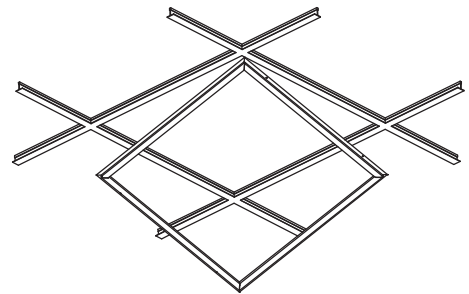

2. Place fixture above the T-grid

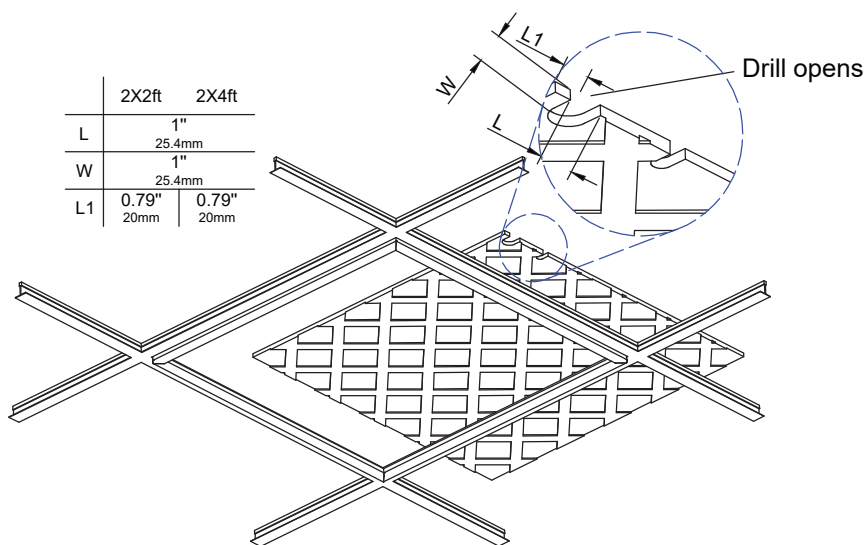

3. Place the ceiling tile above the fixture.

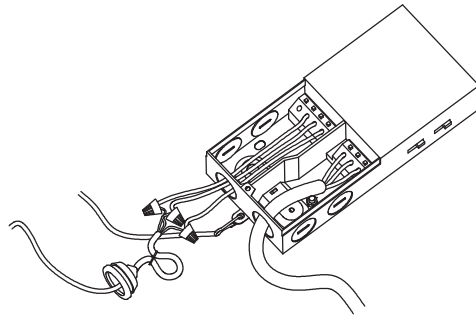
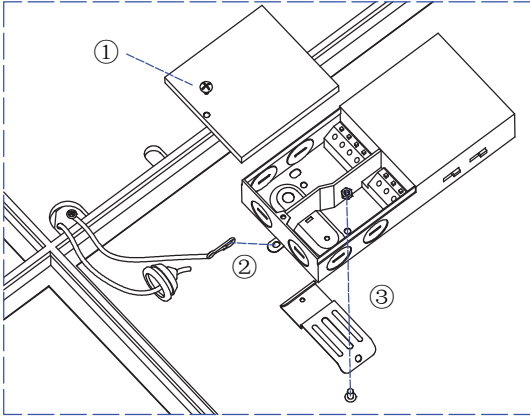

(A-D) Open driver box  
Connect the safety cable  
Lock driver box L bracket with screw+nuts

3. Remove driver cover screw [1]  
Attach Safety Cable [2]  
Secure driver box L bracket with screw and nuts [3].

4. Remove another knock-outs, connect the power and dimming wires in the the driver box, according to the wiring diagram.

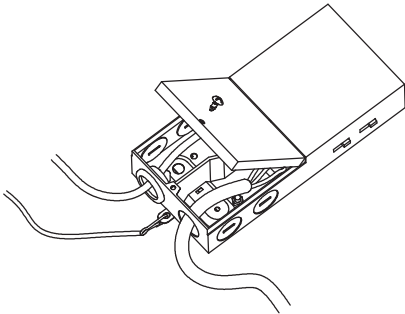

5. Close driver box cover

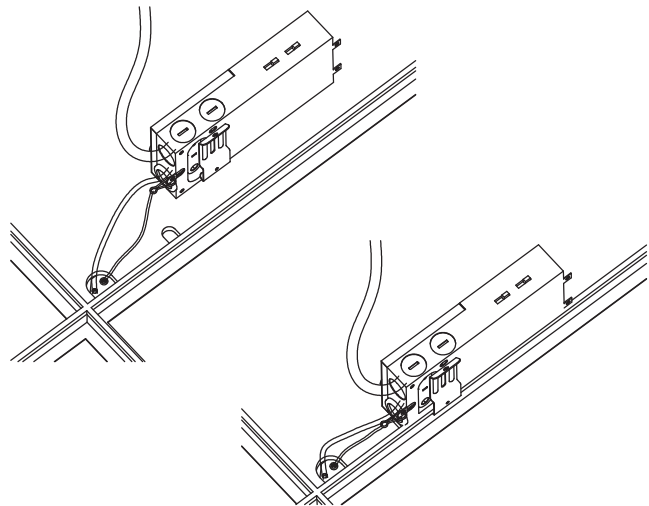

6. Attach and secure driver box to T-grid with L- Bracket

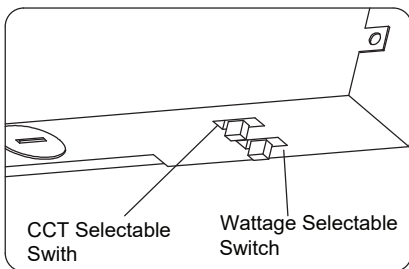

7. Select desired CCT and Wattage.

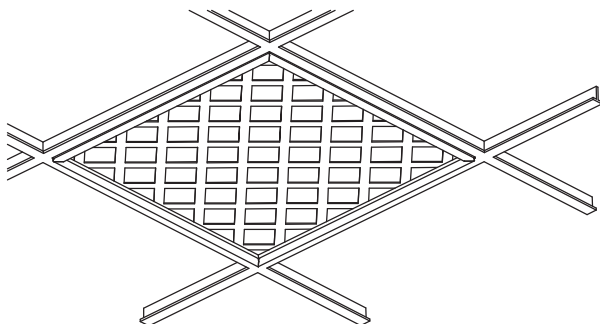

8. Installation Complete

**Wire Diagram**

