

RL™ Series

Recessed Linear Edgelit Panel

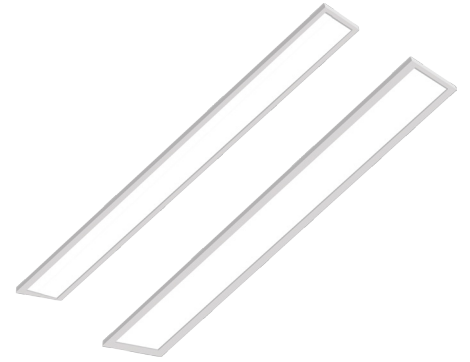

DESCRIPTION

The RL™ Series Recessed Linear Edgelit panel is the ideal recessed mounted fixture with its ability to be CCT selectable allows full temperature control for a versatile solution in a wide variety of applications. With two width sizes and a visual comfort prismatic lens, the RL™ Series provides uniform illumination without sacrificing high performance. The RL™ Linear Series carries its driver externally while still maintaining thinness. The extruded aluminum frame provides strength and durability, ensuring reliable and consistent performance.

APPLICATIONS

Commercial, Retail, Hospitality, Facilities, Healthcare, Hallways, Schools

FEATURES



RL™ Series
RL4-4: 40W (3,600 lm)
RL4-6: 40W (4,000 lm)

FOR RECESSED MOUNTING

Construction

Extruded aluminum frame for strength and durability, the seamless frame prevents light leak in the corners. Two aperture size available. The acrylic prismatic light guide panel provides excellent shielding and fully illuminated appearance.

Electrical

Input voltage: 120-277VAC
12W Emergency Inverter available
10W Bodine Inverter available.

Projected L70: 54,000+ hours
Warranty: 5 Years
Efficacy: Up to 100 LpW
0-10V Dimming

Optical System

120° beam angle with uniformed edge to edge illumination provides excellent ambient lighting.

Installation/ Mounting

RL™ Series ideally for recessed mounting earthquake clips included (Standard)



Damp Location Rated



0-10V Dimming

Warranty

5 Year Warranty.
See warranty documentation for more information.

Controls/Dimming

0-10V Dimming (10%)
CCT Switchable between 3000K, 3500K, 4000K.



CCT Switchable



*90+ CRI Option



Emergency Inverter Option

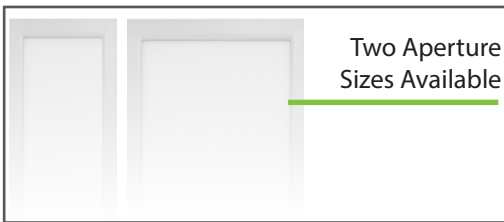

Ordering Information

EXAMPLE: RL4-4-40-C-U-D-RM

Series	Width	Wattage	CCT Switchable	Input Voltage	Control	Mounting	Accessories/Option
RL4	4 - 4" 6 - 6"	40 - 40W	C - 3000K/3500K/4000K	U - 120-277VAC	D - 0-10V Dimming	RM - Recessed Mount (Standard)	ELIS10CDF (Bodine Inverter 10W) WP-CEP-12C-200VPE1 (EM Inverter 12W) T-BR-EM (T-Bar Bracket for EM Backup) *90CRI (Option)

Specifications and Dimensions subject to change without notice.

Optional accessories are purchased separately.

*MOQ and longer lead times may apply, please contact customer service for more information.

Performance Information

Input Voltage	120-277VAC
Input Frequency	50/60Hz
Wattage	See Performance Table
Delivered Lumens	See Performance Table
Efficacy	See Performance Table
CRI	>80 or (>90+ Optional)
Available CCT	3000K, 3500K, 4000K
Projected L70	54,000+ hours
Power Factor	>0.9
THD	<20%
Dimming	0-10V (10%)
Operating Temp.	-22°~122°F
IP Rating	Damp location rated

Photometric Data

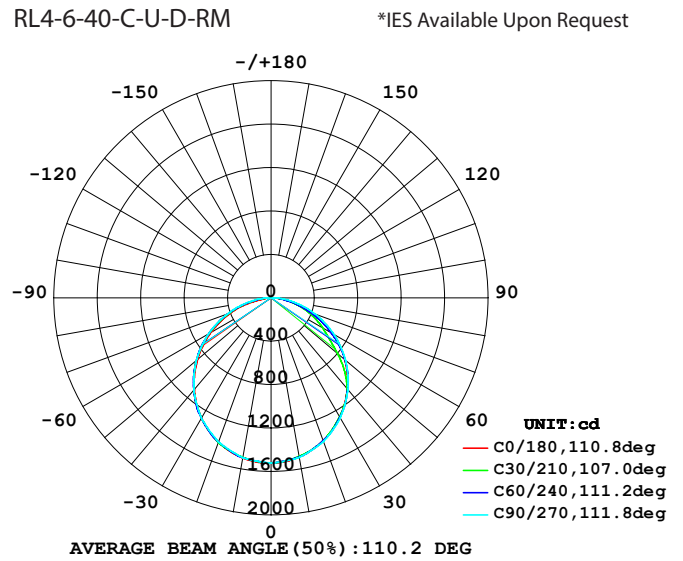

Performance Table

SKU	Wattage (W)	4000K	
		Delivered Lumens (lm)	System Efficacy (lm/W)
RL4-4-40-C-U-D	40	3600	90
RL4-6-40-C-U-D	40	4000	100

Product Dimensions

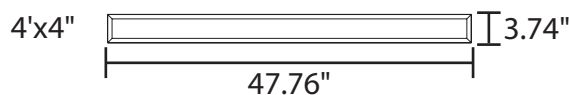

Weight: 4.96 lbs.

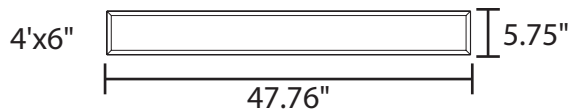

Weight: 6.27 lbs.

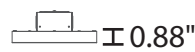

Width

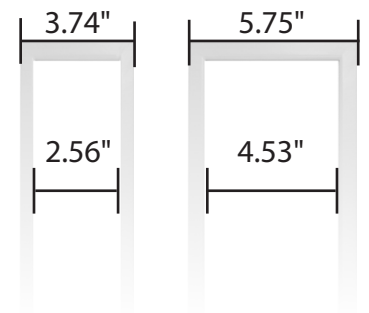

Driver Box

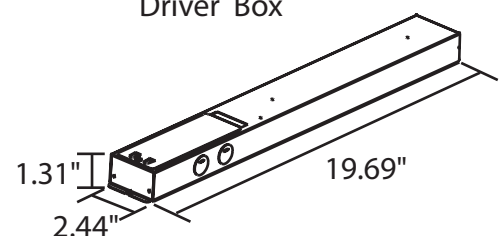

Performance Information



Bodine Inverter 10W
(Optional)
[ELIS10CDF]



Emergency Inverter 12W
(Optional)
[WP-CEP-12C-200VPE1]



T-Bar Emergency Battery
Bracket
[T-BR-EM]