

ThinTek™ Mini S

Edge Lit Downlight

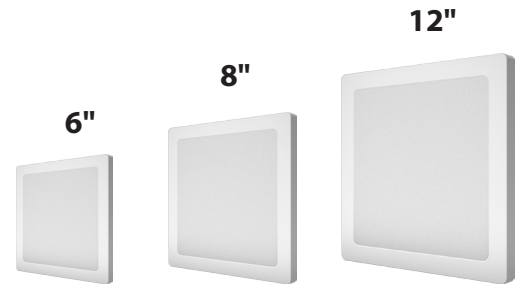

DESCRIPTION

The ThinTek™ Mini S low profile surface mounted downlight is an ideal solution for ceiling or surface mount applications. This 0.6" ultra-slim luminaire is the thinnest available option with an integral driver for existing junction boxes, can lights or new construction applications.

APPLICATIONS

Residential, Institution, Hospitality, Retail, Offices, Schools, Basement remodels, Kitchens and Hallways.

FEATURES

Construction

Injection molded white thin profile and lightweight design. It comes in four optional trim pieces that are easily installed: Chrome, Satin Nickel, Matte Black. Trim pieces are attached using integral magnets.

Optical System

Glare controlling lens for comfortable light distribution. Provides a 110° beam angle.

Warranty

36,000 Hours warranty.
See warranty documentation for more information.

Electrical

Integrated driver with short circuit protection.
Input voltage: 100-277VAC

Installation/ Mounting

Surface Mounting and Torsion Clip Mounting.
Multiple Color Trims Available.

Controls/Dimming

0-10V Dimming

100~277VAC/0-10V Dimming

ThinTek™ Mini S

6", 12W (1,000 lm)
8", 18W (1,530 lm)
12", 24W (2,160 lm)

Projected L70: 60,000+ hours
0-10V Dimming

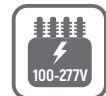

100-277VAC



0-10V Dimming



Thin Profile



90+ CRI



Damp Location

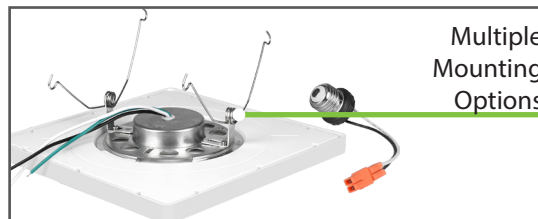
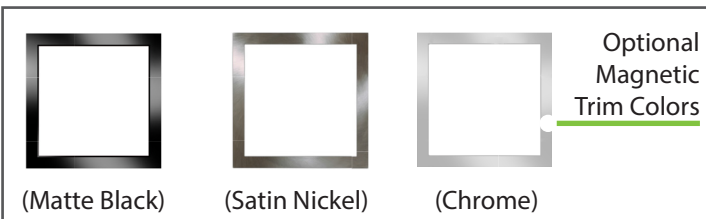

Ordering Information

EXAMPLE: 880612-S-TM-50-U-D

LED Panel	Size/Wattage	Shape/Type	Series	CCT	Input Voltage	Dimming	CRI
88	0612 - 6 in/ 12W 0818 - 8 in/ 18W 1224 - 12 in/ 24W	S - Square	TM - ThinTek™ Mini	30 - 3000K 40 - 4000K 50 - 5000K	U - 100-277VAC	D - 0-10V Dimmng	90CRI (Standard)
						Trim Option	Mounting Option
						Example: 8806-S-BL	88-TC-S (5/6 Torsion Clip Retrofit Kit)
						Size	Trim Finish
						8806-S (6inch)	BL (Matte Black)
						8808-S (8inch)	SN (Satin Nickel)
						8812-S (12inch)	CH (Chrome)

Specifications and Dimensions subject to change without notice.

*MOQ and longer lead times may apply, please contact customer service for more information.

Optional Trim and Mounting Options are purchased separately.

Performance Information

Input Voltage	100-277VAC
Input Frequency	50/60Hz
Wattage	See Performance Table
Delivered Lumens	See Performance Table
Efficacy	See Performance Table
CRI	>90
Available CCT	3000K, 4000K, 5000K
Projected L70	60,000+ hours
Power Factor	>0.9
THD	<20%
Dimming	0-10V Dimming
Operating Temp.	-4°~104°F

Photometric Data

*IES Available Upon Request

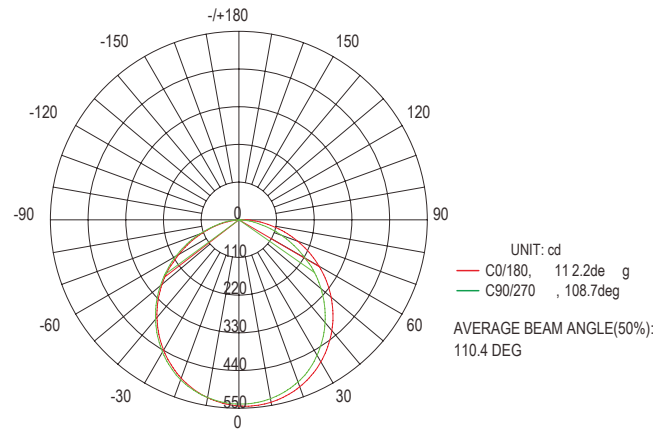

Performance Table

SKU	Wattage (W)	5000K	
		Delivered Lumens (lm)	Efficacy (lm/W)
880612-S-TM-50-U-D	12	1000	80
880818-S-TM-50-U-D	18	1530	85
881224-S-TM-50-U-D	24	2160	90

Product Dimensions

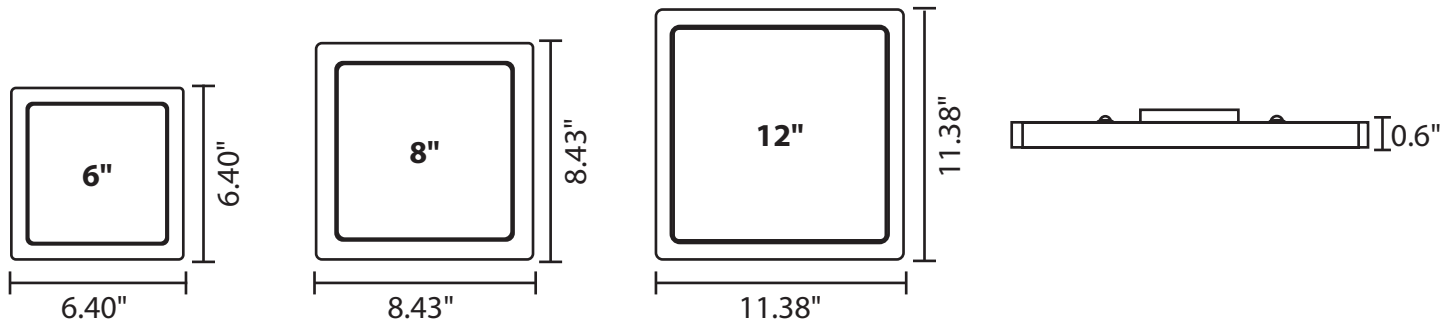

Installation Kits and Accessories

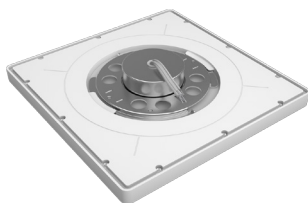

**Surface Mount Kit
(Included)**

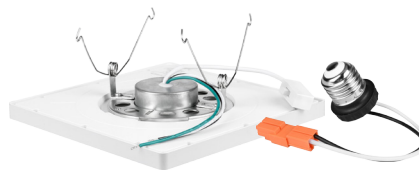

**Torsion Clip Kit
(For 6" Recess Housing)
Housing Not Included
88-TC-S**



**Trims
(Matte Black, Satin Nickel,
Chrome)**